



keonn

Modular RFID
Components

Advantenna-p33 TM

RFID UHF pencil beam antenna





Benefits:

- Narrow beam in two directions
- High gain
- Very thin form factor

Applications:

- Overhead real-time inventory systems
- Fitting rooms
- Magic mirrors
- Doors and corridors

Product overview

Advantenna-p33 is a compact RFID UHF 3x3 elements patch antenna with circular polarization and a radiation pattern characterized by a pencil beam shape (40°/40°).

This radiation pattern makes this antenna ideal for many RFID applications such as overhead real-time inventory systems, magic mirrors and fitting rooms.

A set of Advantenna-p33 can be installed hanging from the ceiling in order to identify and locate tagged items in a given space in real-time.

In retail stores, Advantenna-p33 can be installed at the ceiling, over each fitting room. In this position, and thanks to its high directivity, the RFID system detects the RFID tags located in the corresponding fitting room, while minimizing the detection of items located in neighboring fitting rooms or in areas nearby.

Holder available specially designed for this model of antenna: [AdvanHolder-p33](#)

Connector options



Flange straight

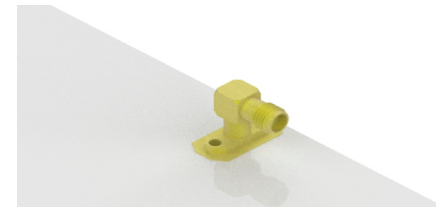

Flange right angle

Flange right angle connector with rotation

Default

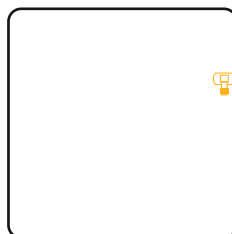

90 degrees

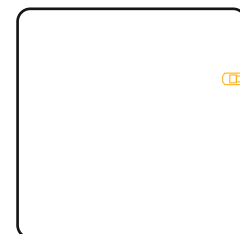

180 degrees

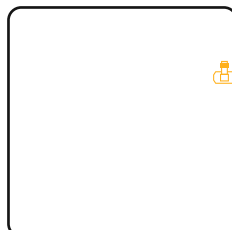

270 degrees

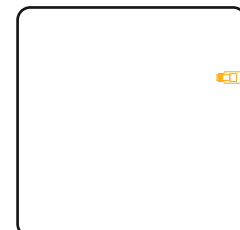

Antenna radiation pattern for 865,6 MHz - 867,6 MHz frequency band:

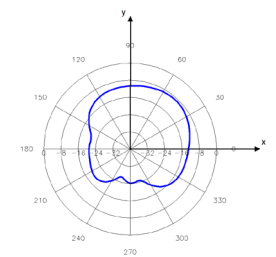
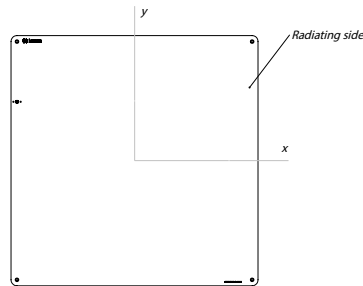
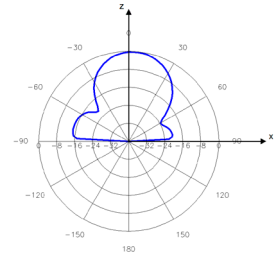
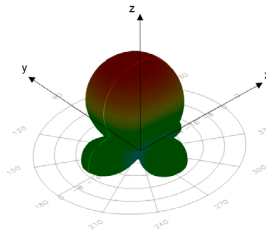

*Front-to-back ratio not drawn

Antenna radiation pattern for 902 - 928 MHz frequency band:

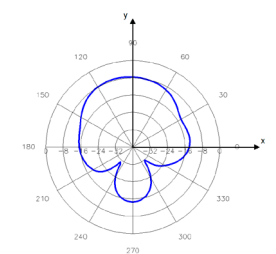
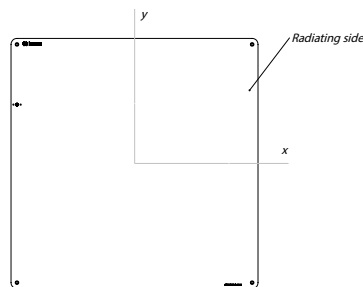
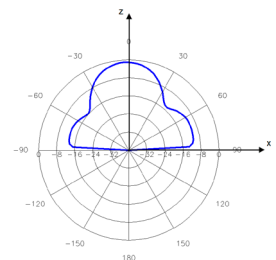
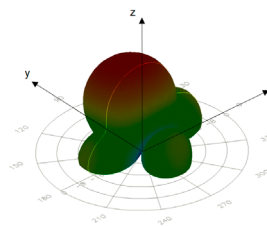

*Front-to-back ratio not drawn



Technical specifications

Operating Frequency EU Version	865 - 868 MHz (ETSI EN 302 208)
Operating Frequency US Version	902 - 928 MHz (FCC part 15)
Antenna Technology	Patch
Radiation pattern	Pencil beam
Gain	EU version 10.7 dBiC (Typical), 10.8 dBiC (Max) 8.0 dBiL* US version 10.6 dBiC (Typical), 10.6 dBiC (Max) 7.8 dBiL*
VSWR	< 1.5:1 (Typical)
Beam width (AZ / EL)	40° / 40°
Sidelobe level	< -15 dB
Front-to-Back Ratio	< -20 dB
Polarization	Circular - LHCP (Left Hand Circular Polarization)
Axial Ratio	EU version* At Boresight 0.3 dB At 3dB Beamwidth 0.5 dB (Typical), 1.9 dB (Max) US version* At Boresight 0.4 dB At 3dB Beamwidth 0.7 dB (Typical), 1.9 dB (Max)
Input Impedance	50 Ω
Connector	SMA or MCX Flange or flange right angle
Regulation	ROHS - EU Directive 2015/863 WEEE - EU Directive 2012/19/EU REACH - EC No 1907/2006 ETSI EN 302 208
IP rating	Indoor antenna IP62**
Temperature range	-20°C to +80°C
Size excluding connector	417 mm x 417 mm x 3.3 mm 16.4 inches x 16.4 inches x 0.13 inches
Size with flange connector	417 mm x 417 mm x 15 mm 16.4 inches x 16.4 inches x 0.6 inches
Antenna weight	1050 g

*Measured at the center of the band

** IP rating in this case indicates the conditions that the antenna can withstand at specific times and, afterwards, continue working normally, they are not conditions under which it can work permanently.

Mechanical specifications

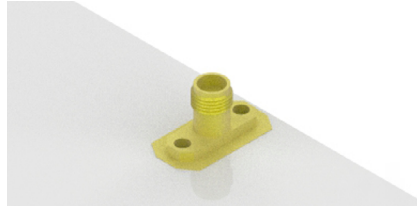

Flange straight

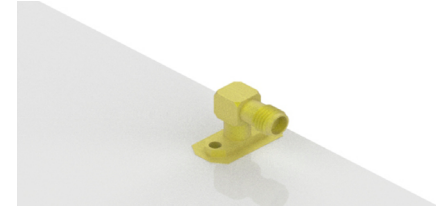

Flange right angle

Flange straight connector (EU)

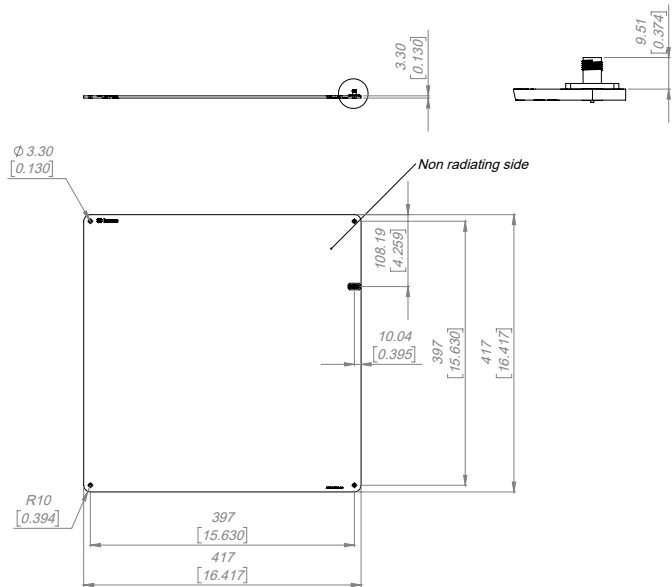
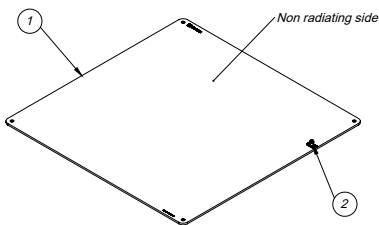

Flange right angle connector (EU)

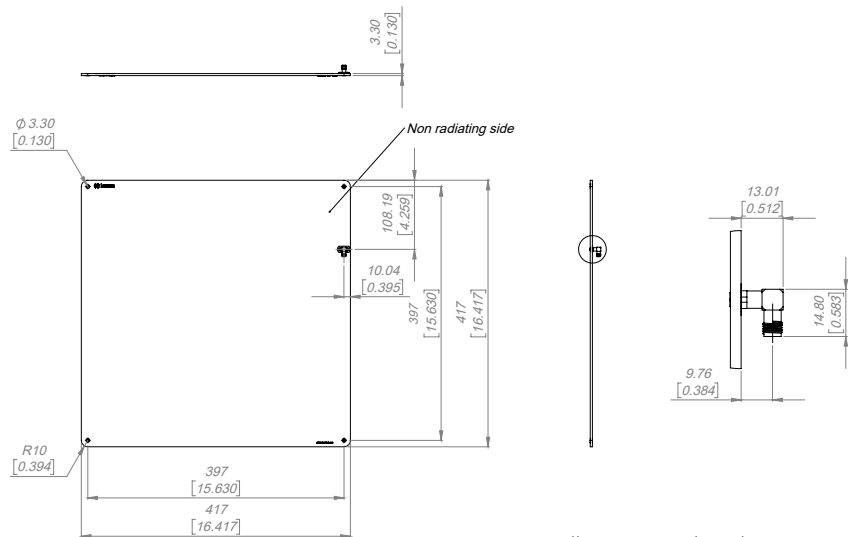
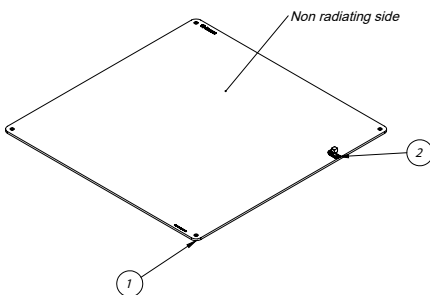

Units in millimeters and [inches]

Mechanical specifications

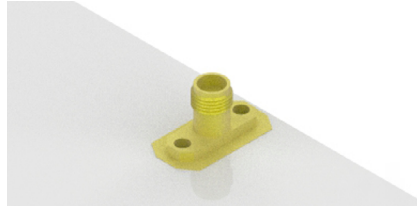

Flange straight

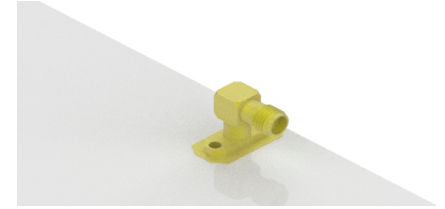

Flange right angle

Flange straight connector (US)

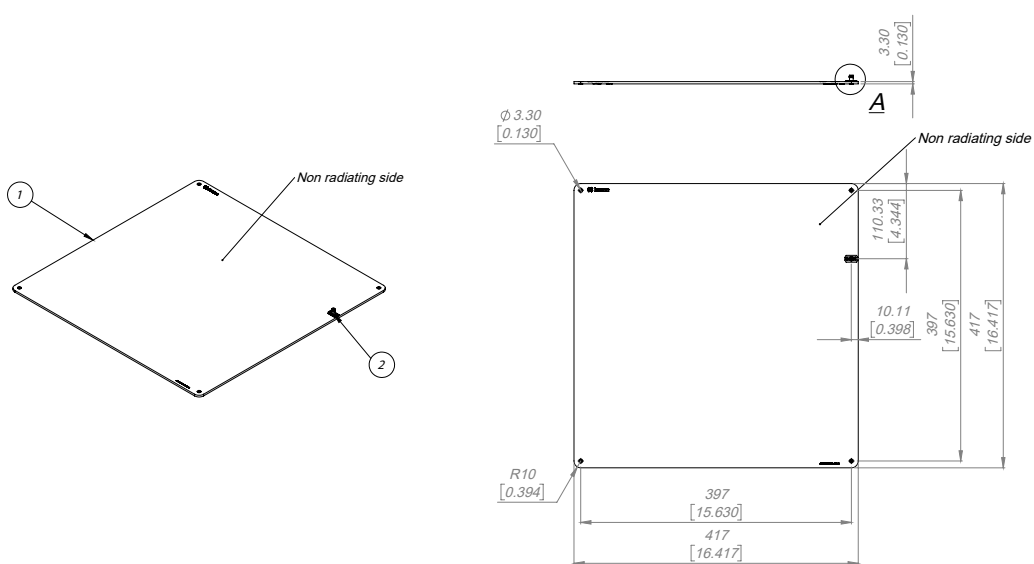

Flange right angle connector (US)

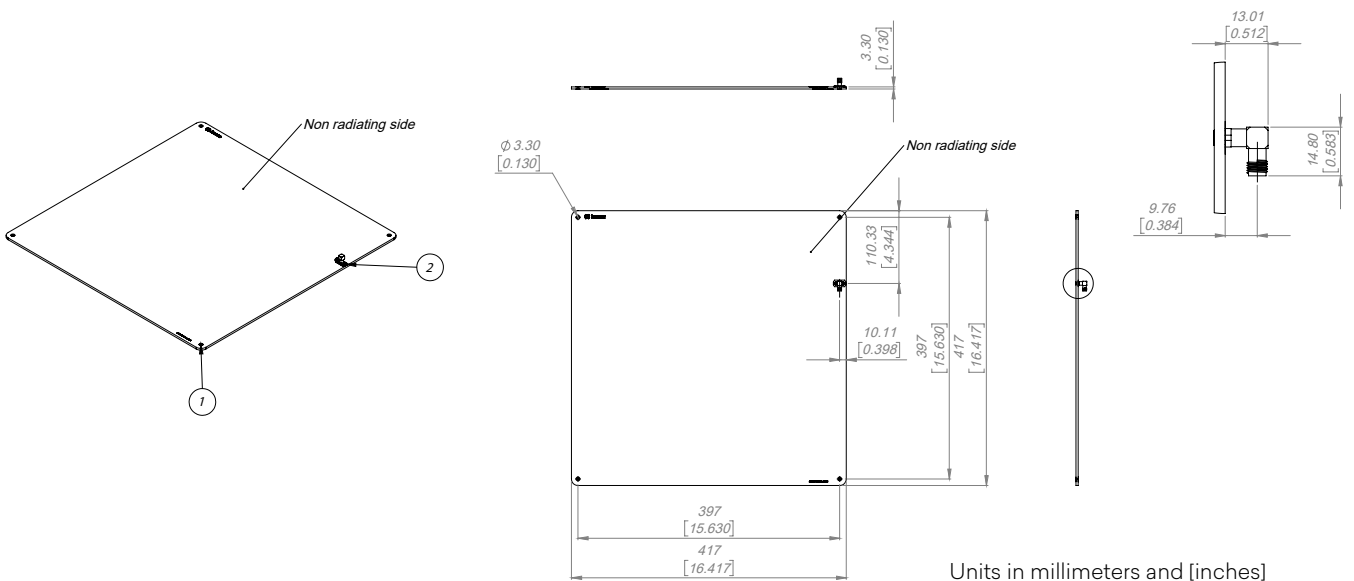

Units in millimeters and [inches]

Product codes for ordering

ADAN-p33	FF	-	CS	COR	CT	-	mmm	
								FF = frequency band
	EU							865,6 MHz - 867,6 MHz
	US							902,0 MHz - 928,0 MHz
								Connector shape
			FL					Flange straight
			FR					Flange right angle
								Connector orientation (only for right angle SMA connector)
								Default orientation
				90				Rotated 90° counterclockwise
				180				Rotated 180° counterclockwise
				270				Rotated 270° counterclockwise
								Connector type
					SMA			SMA connector
					MCX			MCX connector (only available in edge mount and flange straight)
								Model
							200	Model number

Examples:

ADAN-p33EU-FLSMA-200:

- Advantenna-p33
- Frequency band : 865,6 MHz - 867,6 MHz
- **Flange straight** connector
- **SMA** connector
- Model **200**

ADAN-p33US-FRSMA-200:

- Advantenna-p33
- Frequency band : 902,0 MHz - 928,0 Mhz
- **Flange right angle** connector
- Default connector orientation
- **SMA** connector
- Model **200**

ADAN-p33EU-FR270SMA-200:

- Advantenna-p33
- Frequency band : 865,6 MHz - 867,6 MHz
- **Flange right angle** connector
- Connector rotated 270° counterclockwise
- **SMA** connector
- Model **200**

Disposal of the product

Do not dispose the product in municipal or household waste. Please check your local regulations for disposal/ recycle of electronic products.





Copyright © Keonn Technologies S.L.
All rights reserved.

Information in this publication
supersedes all earlier versions.
Specifications subject to change
without notice.

